



IBM 1404 PRINTER

The IBM 1404 Printer, Model 2 (Figure 1), is another output medium for the IBM 1401 Data Processing System, and is available for Models B, C, E, and F. It is a combination printer, capable of processing either cut-card forms or continuous forms. The 1404 retains all the basic features of the IBM 1403 Printer — tape-controlled carriage, printing unit, and continuous forms carriage, and incorporates a newly designed card feeding mechanism. Under the control of the 1401 stored program and the tape-controlled carriage, this unit can print on continuous forms at a rated speed of 600 lines per minute; or it can print on card documents at a maximum rate of 800 cards per minute.

Simply by positioning a movable print unit before the card feeding mechanism and pushing a switch, an operator can change from continuous forms feeding

to card document feeding. Conveniently located controls, hoppers, and stackers, all accessible from the front, permit easy operation.

The 1404 can process cards of many sizes, ranging from a single 51-column card to an 80-column card with an 80-column stub. It can also process two cards (either 51- or 80-column) at one time. As many as 25 lines of data, either from 1401 core storage, or from the card itself, can be printed on a card.

Many businesses, in a variety of industry classifications, need accuracy and speed in printing on such card documents as checks, earnings statements, premium notices, bills, and proxy notices. The 1404 provides this accuracy and speed, and is flexible enough to be quickly converted for applications requiring continuous forms printing.

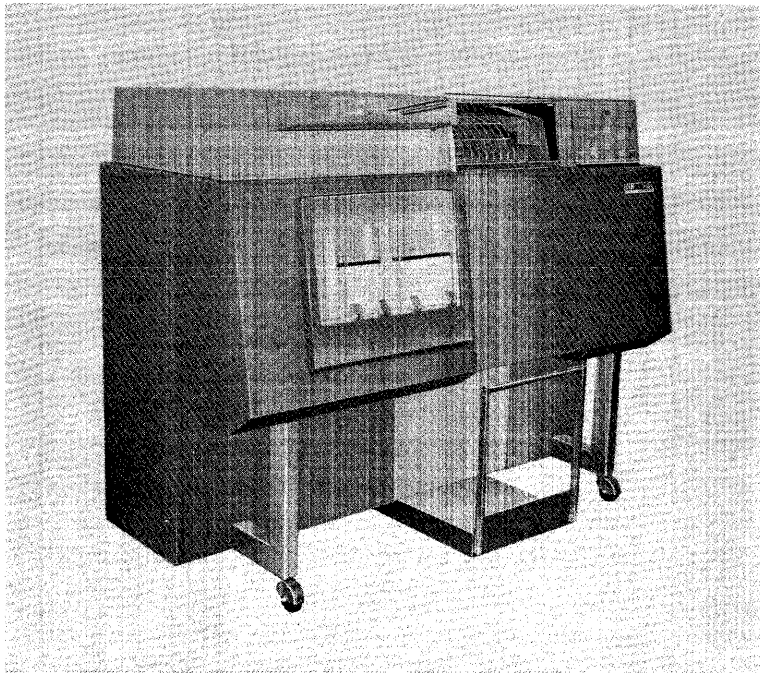

Figure 1. IBM 1404 Printer, Model 2

Functional Characteristics

The right-hand side of the printer contains the continuous forms feed mechanism. The card document feeding mechanism is at the left. The print unit, consisting of the type chain, motor, ribbon, and hammers, can be moved laterally and positioned in front of either feed mechanism to print on continuous forms or cards.

Continuous Forms Feed

To print on continuous forms, the print unit is positioned on the right-hand side, and a *card-feed switch* on the printer console is turned OFF. In this instance, the operation of the printer, print unit, and carriage are the same as for the IBM 1403 Printer (see IBM 1401 Data Processing System Reference Manual, Form A24-1403).

Card Document Feed

The card-feeding mechanism consists of two sets of card levers and feed rolls that can be set to operate as one, or as two separate card *channels*. The large, single, card hopper (Figure 2), located at the front of the printer, can also be set up to accommodate one, or two separate card stacks. The hopper has a capacity of 1200 standard IBM cards, or 900 IBM-stock postcards. The three throats can be adjusted easily to accommodate either type of card.

Depending on the particular application, one or two cards can be processed at one time, and fed either 9- or 12-edge first. The application also determines the setting of a *channel select rotary switch* located on

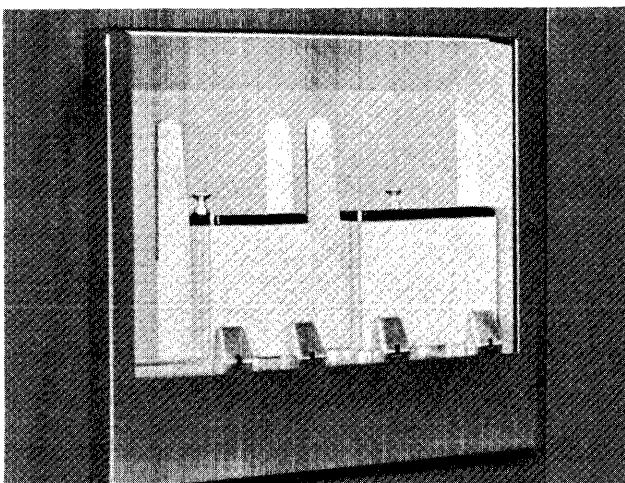

Figure 2. Card Feed Hopper

the console. This switch controls the card-lever circuitry (left or right channel) and sets up the proper 1401 reading circuits (for the *read-compare feature*).

Card Forms

The card document feeding mechanism can feed IBM cards of either standard or postcard stock, and it can feed one or two cards at a time. If the printer is to process single cards, they can vary in width from 51-column cards to 80-column cards with 80-column stubs.

If the printer is to process two cards at a time, 51- or 80-column cards can be processed in either card channel.

Setting the Hoppers

The nature of the card printing operation determines how the four hopper side plates are set. There are two (left and right) side plates for each channel, and two settings for each *left* side plate.

N (NORMAL) SETTING

This setting is used when 80-column cards are being processed in the left channel. A groove in the guide support shaft is the location of the *N* setting of the left side plate. An aligning hole in the side plate block aids in locating this groove, into which a knurled thumbscrew is tightened (Figure 3).

The right-hand side plate of the left channel is also set by a knurled thumbscrew. It should be set so that there is slight clearance between the end of the card and the side plate.

If the read-compare feature is installed, this *N* setting for the left channel permits card columns 1-80 to be read by read-compare brushes 1-80.

For two-card operations, or when only the right-hand channel is used, the left side plate of the right-hand channel is set at its *N* position. The right-hand side plate, again, is set according to the size of the cards being processed.

If the read-compare feature is installed, this *N* setting for the right-hand channel permits card columns 1-80 to be read by read-compare brushes 81-160.

For operations that involve cards wider than the standard 80-column card, the left channel side plates are unused and moved out of the way to the extreme left of the guide support shaft. In this instance, the left side plate of the right-hand channel is moved to the *N* setting of the left channel, and the right-hand side plate is adjusted according to the width of the forms.

S (SHORT CARD) SETTING

This setting is used when 51-column cards are being processed in the left channel. Adjusting the left-channel hopper plates parallels the procedure described for the *N* (normal) setting.

If the read-compare feature is installed, this *S* setting for the left channel permits columns 1-51 to be read by read-compare brushes 16-66.

For operations involving the simultaneous feeding of two short cards, or when using only the right-hand channel for short cards, the left side plate of the right-hand channel is set at its *S* position. The right-hand side plate is set according to the width of the forms.

If the read-compare feature is installed, this *S* setting for the right-hand channel permits columns 1-51 to be read by read-compare brushes 96-146.

Adjusting the Throat

The three card throats can be adjusted by the operator to feed either IBM standard or postcard stock. In most instances, he adjusts the throat nearest the center of the form to be used. However, if a card with a stub must pass through more than one throat, the others are set slightly higher than the centermost throat.

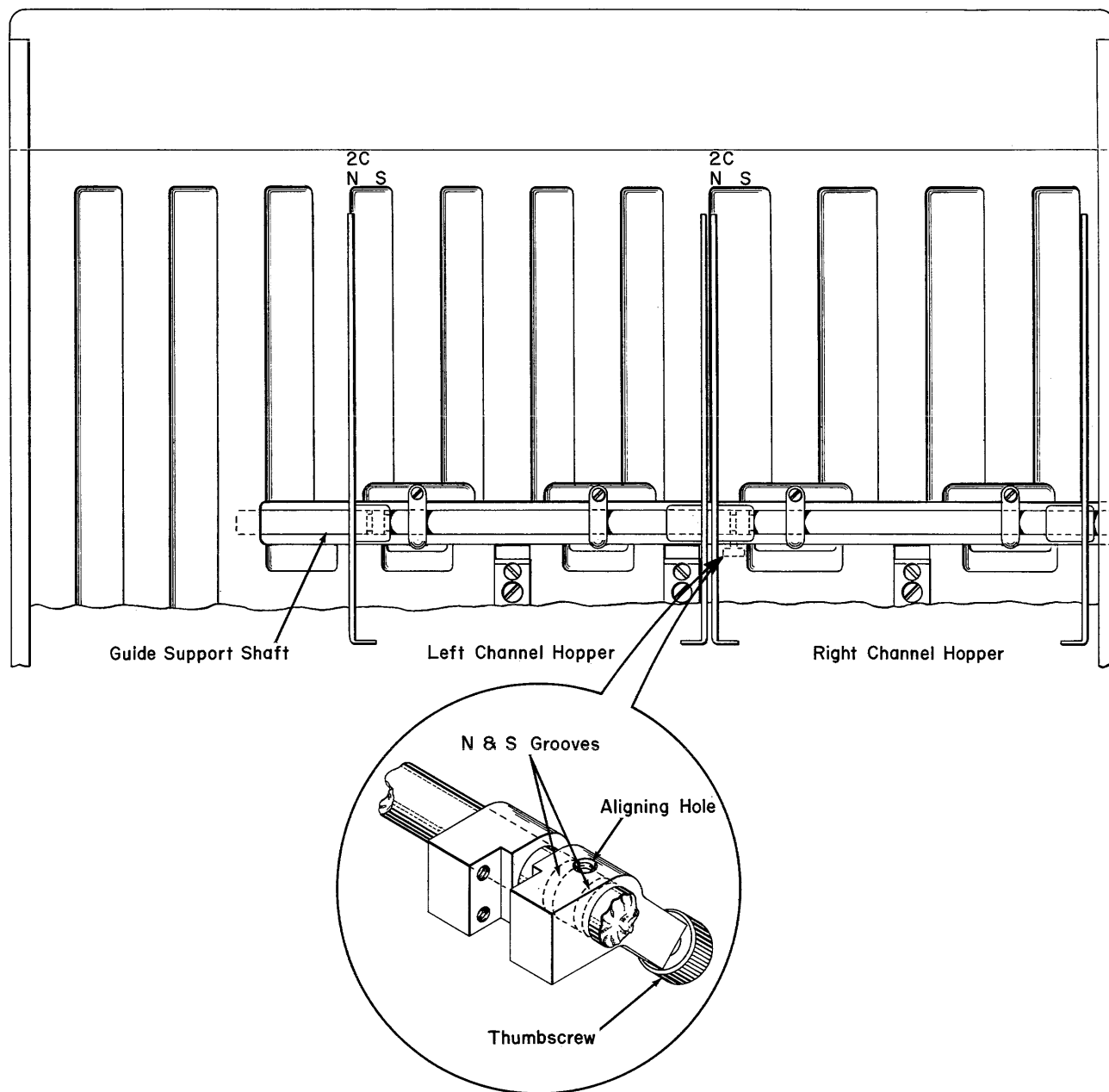

Figure 3. Hopper Side Plate Adjusting Mechanism

To adjust a throat, first loosen a wing nut at the back of the hopper (Figure 4). Then set the calibrated adjusting screw to the desired dimension. Each line represents a one-thousandth of an inch opening. For standard IBM cards, set the opening at 10 thousandths; for postcard stock, set it at 12 thousandths. After making the adjustment, tighten the wing nut to lock the throat at the desired opening.

Card Feeding

In the IBM 1404 Printer, card feeding is under the control of the tape-controlled carriage and the 1401 stored program. Cards are fed from the hopper(s), past the read-compare brushes (special feature) to a point just ahead of the print station. Under the control of the carriage tape, the cards are then advanced to the first printing line. The program determines how many lines print on each card. After the printing operation, the cards are ejected into the stacker, located on the top of the machine. Figure 5 is a side-view schematic of the card transport mechanism.

NOTE: Cards are stacked in reverse of the order in which they are loaded into the hopper.

The card transport mechanism facilitates the recovery of cards, regardless of their location in the card path. To gain access to the card path:

1. release, and swing-open the hopper mechanism to the left

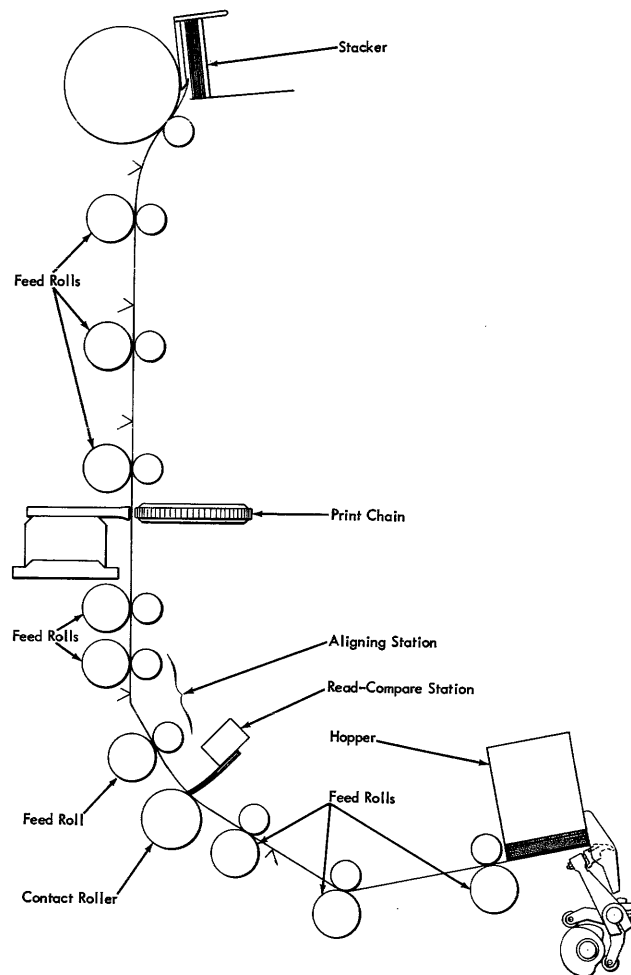

Figure 5. Card Transport Schematic, IBM 1404

2. release, and swing the print chain and ribbon mechanism to the right
3. release, and swing-up the roller frame

If the read-compare feature is installed, the read-compare brush blocks can be easily removed.

Print Unit

For printing card documents, the print unit is positioned on the left side of the 1404 and the card-feed switch on the printer console is turned ON.

Lateral Movement

To move the print unit laterally, the unit is unlocked by raising the *translator knob*; the same knob is used to move the unit to the left (Figure 6), and is re-locked in one of the following positions:

N (NORMAL) SETTING

When the indicator, located just below the translator knob, is above the *N* decal on the printer frame, the knob can be pushed down and locked in this normal

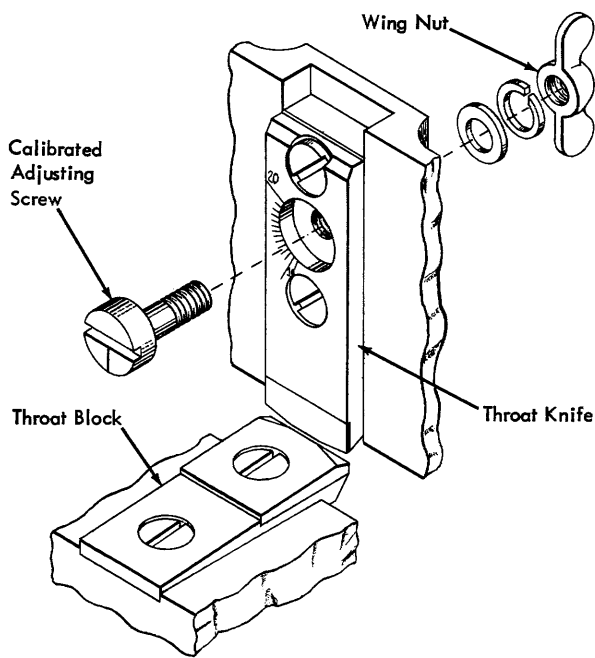

Figure 4. Throat Adjusting Mechanism

setting. This setting is used when 80-column cards are being processed in either or both channels. In this instance, the left hopper side plates are also set at *N*.

With the print unit and hopper side plates at this setting, the first print position is $\frac{1}{4}$ inch from the left edge of the left-channel card. Similarly, the 78th print position is $\frac{1}{4}$ inch from the left edge of the right-channel card. Because there are 132 print positions in all, printing on right-channel cards is limited to the last 55 positions (78-132).

S (SHORT CARD) SETTING

When the indicator, located just below the translator knob, is over the *S* decal on the printer frame, the knob can be pushed down and locked in this short-card setting. This setting is used when 51-column cards are being processed in either or both channels. In this instance, the left hopper side plates are also set at *S*.

With the print unit and hopper side plates at this setting, the 14th print position is $\frac{1}{4}$ inch from the left edge of the left-channel card. Similarly, the 91st print position is $\frac{1}{4}$ inch from the left edge of the right-channel card. Because there are 132 print positions in all, printing on right-channel cards is limited to the last 42 positions (91-132).

2C (TWO CARD) SETTING

When the indicator, located just below the translator knob, is over the *2C* decal, the knob can be locked in this two-card setting. This setting is used in dual-feed operations using cards of the same format in both channels. When the print unit is in this setting, the left hopper side plates are set at *N*.

When the print unit and the hopper plates are at these settings, print positions 1 through 55 are used for the left-channel card printing, and 78 through 132 are used for right-channel card printing.

Printing Characteristics

Printing on continuous forms in the 1404 is performed at the same speeds, and under the same conditions as in the IBM 1403 Printer. Printing is based on a 100 ms cycle. During this cycle, the system is interlocked for 84 ms (alphamerical printing), and processing can take place during the last 16 ms. Forms movement for one line requires 20 ms of this basic cycle (see Figure 14).

Printing on card documents occurs on the top surface of each card as they appear in the hopper. With 8-lines-per-inch spacing, a maximum of 25 lines can be printed on one side of a card. With 6-lines-per-inch spacing, a maximum of 19 lines can be printed on one side.

When printing on the first line of each card, and spacing at 6 lines per inch, the maximum output is

400 cards per minute for each card channel. If printing occurs at 8 lines per inch, this is reduced to 359 cards per minute.

METHOD OF PRINTING

As in the IBM 1403 Printer, the method of printing in the 1404 is through the use of a continuous type chain traveling in a horizontal plane. Any one of 48 different characters can be printed as it is positioned opposite a magnet-driven hammer. These 48 different characters include: 26 alphabetic, 10 numerical, and 12 special characters (& , . □ - \$ * / % # @ ≠). The standard number of print positions is 132.

As each character is printed, it is checked against the corresponding position in the print area of core storage. The machine also checks to insure that each character is printed in the correct print position, that only valid characters are printed, and that overprinting does not occur.

Tape-Controlled Carriage

The tape-controlled carriage, in conjunction with the 1401 program, controls the feeding, spacing, and skipping of both continuous forms and card forms. The carriage is controlled by a punched paper tape that corresponds in length to the length of one or more forms. Holes punched in the tape can stop a form when it reaches any pre-determined printing line.

Line spacing of either 6 or 8 lines per inch is standard. At 6 lines per inch, spacing is performed at a minimum speed of 38 inches per second, and skipping occurs at a minimum of 85 inches per second. The 1404 carriage remains in this high-speed skip until 5 lines

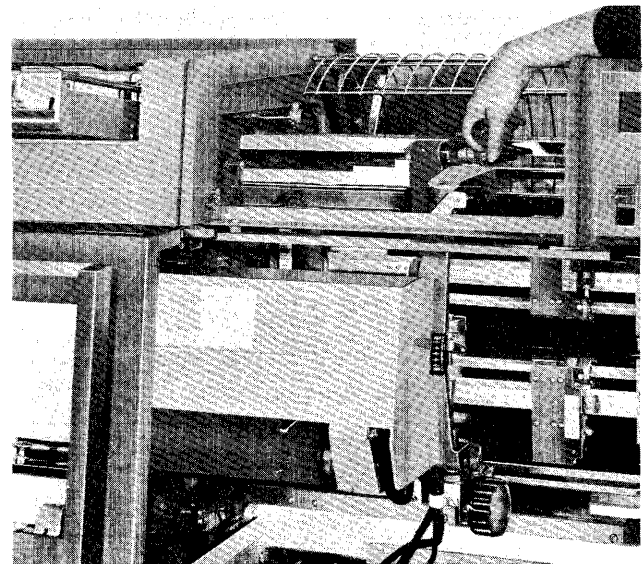

Figure 6. Moving the Print Unit

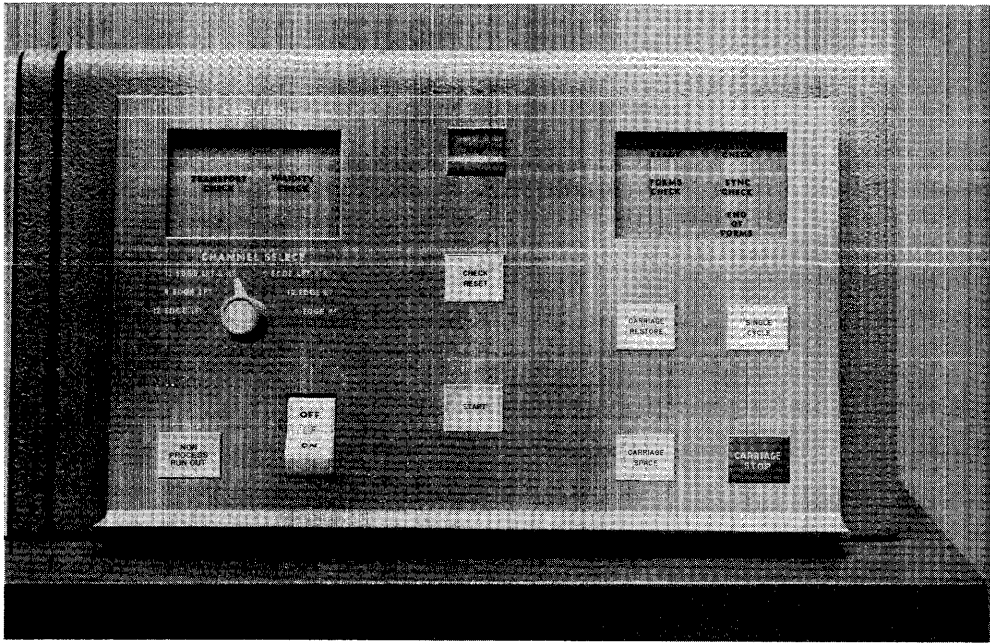

Figure 7. Console, IBM 1404

before it senses the stop impulse. The punched paper tape controls skipping to pre-determined lines. In the tape there are 12 channels, two of which (9 or 12) can be interrogated for overflow.

When printing on card forms, a skip to channel 1 impulse causes a new card to be fed, the card at the aligning station to be moved into the correct printing position, and the card in the printing station to be ejected to the stacker. The channel 1 punch in the tape determines the first printing line of the card.

IBM 1404 Printer Console

The IBM 1404 Printer console (Figure 7) is located in the upper right-hand section of the printer. It contains the keys, switches, and indicator lights that control the operation of the tape-controlled carriage, as well as both feeding mechanisms.

CHECK RESET KEY

Pressing this key resets all printer error indicators. The program can be restarted by pressing the start key.

CARRIAGE SPACE KEY

Each time this key is pressed, the form advances one space.

SINGLE CYCLE KEY

Pressing this key once operates the 1404 for one print cycle. If the end-of-form light is on, pressing this key causes printing until channel 1 in the carriage tape is sensed.

CARRIAGE STOP KEY

If the carriage is in motion, pressing this key stops it. To resume operation, the check reset key must be pressed.

PRINT READY LIGHT

This light turns ON when the printer is in operating condition.

PRINT CHECK LIGHT

This light turns ON to indicate a print error.

FORMS CHECK LIGHT

This light turns ON to indicate paper feed trouble in the forms tractor. The light goes out when corrective action is taken, and the check-reset key is pressed.

SYNC CHECK LIGHT

This light turns ON to indicate that the chain was not in synchronism with the printer comparing unit during a particular print cycle. The printer stops at the end of that print cycle so that the printed line can be inspected for errors. Pressing the check reset key resets the error condition, and turns out the light.

END-OF-FORMS LIGHT

This light turns ON, and the printer stops to indicate an end-of-forms condition.

STOP KEY

This key is used to stop the system. It is not effective until the instruction being executed is completed. Similar stop keys are provided on each of the other units in the system.

CARRIAGE RESTORE KEY

Pressing this key positions the carriage at channel 1 (*home position*). If the carriage feed clutch is disengaged, forms do not move. If it is engaged, the forms move in synchronization with the control tape.

START KEY

This key is used to start the machine after a manual, programmed, or automatic stop. Similar start keys are provided on each of the other units in the system.

Card Feed Controls

These lights, keys, and switches are located on the left side of the console panel, and control the card-document feed.

TRANSPORT CHECK LIGHT

This light turns ON to indicate a card jam or misfeed. Before restarting the operation, correct the condition, and press the non-process runout key.

VALIDITY CHECK LIGHT

If the read-compare feature is installed, an invalid card code read by the read-compare brushes turns this light ON, and turns the validity check indicator ON.

CHANNEL SELECT SWITCH

This rotary switch can be set at any one of 6 positions. The switch setting depends on whether or not both card channels are to be used, and whether cards are to be fed 9- or 12-edge first. If only one channel is used, the card levers in the unused channel are inoperative. If the read-compare feature is installed, the setting of the switch determines whether the 1401 read circuits read 9- or 12-edge first.

NON-PROCESS RUN OUT KEY

This key must be used if the transport check light goes on. After both card hoppers have been emptied, this key ejects all cards from the printer channels.

CARD FEED SWITCH

When this switch is set to the ON position, the card-feeding mechanism is operative. The switch must be set to the OFF position to operate the continuous forms-feed mechanism.

Read-Compare Special Feature

As a special feature for the IBM 1404 Printer, 30 card columns can be read from the card feed channels. With this feature, 80 read-compare brushes are provided for each card channel. A control panel is also provided to select the reading of any 30 of the 160 available positions. Storage locations 334 to 363 are assigned as a read-in area for the data read by the read-compare brushes. Storage position 333 is used for internal programming.

Comparison of data from the card with data in storage is accomplished by using the normal 1401 COMPARE instruction (C AAA BBB). This instruction compares data in the assigned read-in area (from the comparing brushes) with data in any other core-storage area.

When reading is not required, the read-compare brushes should be raised from the contact rollers.

Instructions

The following modified 1401 instructions control IBM 1404 Printer operations. The d-character, 0 (zero), modifies existing instructions for use with the 1404 and/or the read-compare feature.

Read from 1404 Printer

Instruction Format.

| | | |
|-----------------|----------------|--------------------|
| <i>Mnemonic</i> | <i>Op Code</i> | <i>d-character</i> |
| R | <u>1</u> | 0 |

Function. This instruction causes a card to be read, and as many as 30 columns of information to be transferred into core-storage positions 334 to 363. The d-character specifies that this is a read instruction for the 1404.

Word Marks. Word marks are undisturbed.

Timing. $T = .0115 (L_I + 1) + I/O$ ms.

A 1404 card read cycle (I/O time) requires a total of 150 ms. The cycle is divided into three major operations (see section on *Timing*).

Note. The read instruction must always follow the instruction F 1 or the instructions F A and 2.

Address Registers after Operation.

| | | |
|--------------------|--------------------|--------------------|
| <i>I-Add. Reg.</i> | <i>A-Add. Reg.</i> | <i>B-Add. Reg.</i> |
| NSI | Ap | 364 |

Example. Read as many as 30 columns (specified by the 1404 control panel), and transfer the data to IBM 1401 core-storage positions 334-363 (Figure 8).

| LINE | COUNT | LABEL | OPERATION | (A) OPERAND | | | | (B) OPERAND | | | | d | |
|------|-------|-------|-----------|-------------|---|------------|------|-------------|---|------------|------|---|---|
| | | | | ADDRESS | ± | CHAR. ADJ. | IND. | ADDRESS | ± | CHAR. ADJ. | IND. | | |
| 0 | 1 | 0 | R | | | | | | | | | | 0 |

Assembled Instruction: 1 0

Figure 8. Read a Card, IBM 1404

Write a Line

Instruction Format.

| | |
|-----------------|----------------|
| <i>Mnemonic</i> | <i>Op Code</i> |
| W | <u>2</u> |

Function. This instruction causes the data in the print area to be transferred to the printer. The program continues after printing is complete. The printer takes an automatic space after printing a line.

Word Marks. Word marks are not affected.

Timing. $T = .0115 (L_I + 1) + I/O$ ms.

Address Registers after Operation.

| | | |
|--------------------|--------------------|--------------------|
| <i>I-Add. Reg.</i> | <i>A-Add. Reg.</i> | <i>B-Add. Reg.</i> |
| NSI | Ap | 332 |

Example. Print the data in the print area (Figure 9).

| LINE | COUNT | LABEL | OPERATION | (A) OPERAND | | | | (B) OPERAND | | | | d | |
|------|-------|-------|-----------|-------------|---|------------|------|-------------|---|------------|------|---|---|
| | | | | ADDRESS | ± | CHAR. ADJ. | IND. | ADDRESS | ± | CHAR. ADJ. | IND. | | |
| 0 | 1 | 0 | W | | | | | | | | | | 0 |

Assembled Instruction: 2

Figure 9. Write a Line

Example. Test to see if there was an invalid card code read by the read-compare brushes during the last read operation in the 1404. If there was an error, branch to location 0787 (Figure 12).

| LINE | COUNT | LABEL | OPERATION | (A) OPERAND | | | | (B) OPERAND | | | | d | | | | | |
|------|-------|-------|-----------|-------------|----|------------|------|-------------|----|------------|------|----|----|----|----|----|----|
| | | | | ADDRESS | ± | CHAR. ADJ. | IND. | ADDRESS | ± | CHAR. ADJ. | IND. | | | | | | |
| 3 | 5 | 7 | 13 | 14 | 15 | 16 | 17 | 23 | 24 | 25 | 26 | 27 | 28 | 34 | 35 | 36 | 39 |
| 0 | 1 | 0 | | B | | | | 0 | 7 | 8 | 7 | | | | | | 0 |

Assembled Instruction: B 787 0

Figure 12. Test and Branch

Compare

Instruction Format.

| | | | |
|----------|----------|-----------|-----------|
| Mnemonic | Op Code | A-address | B-address |
| C | <u>C</u> | xxx | (363) |

Function. The data in the A-field is compared to an equal number of characters in the B-field. The bit configuration of each character in the two fields is compared. If there is an unequal comparison, an indicator turns on. This indicator can then be tested by a BRANCH IF INDICATOR ON instruction.

If the read-compare feature is installed in the IBM 1404 Printer, any of the 30 (334-363) core-storage locations, assigned as a read-in area from the 1404, can be compared with any other field.

Word Marks. The first word mark encountered stops the operation. If the A-field is longer than the B-field, the extra positions in the A-field are not compared. If the B-field is longer than the A-field, an unequal compare results.

Timing. $T = .0115 (L_I + 1 + L_A + L_B)$ ms.

Note. Both fields must have exactly the same bit configuration to be equal.

Address Registers after Operation.

| | | |
|-------------|------------------|------------------|
| I-Add. Reg. | A-Add. Reg. | B-Add. Reg. |
| NSI | A-L _w | B-L _w |

Example. Compare the 10-digit serial number of one card with that of the preceding card (moved to locations 681-690). Then test the unequal-compare indicator. If the serial numbers are equal, continue the program in sequence. If they are unequal, branch to location 0927 for the next instruction (Figure 13).

| LINE | COUNT | LABEL | OPERATION | (A) OPERAND | | | | (B) OPERAND | | | | d | | | | | |
|------|-------|-------|-----------|-------------|----|------------|------|-------------|----|------------|------|----|----|----|----|----|----|
| | | | | ADDRESS | ± | CHAR. ADJ. | IND. | ADDRESS | ± | CHAR. ADJ. | IND. | | | | | | |
| 3 | 5 | 7 | 13 | 14 | 15 | 16 | 17 | 23 | 24 | 25 | 26 | 27 | 28 | 34 | 35 | 36 | 39 |
| 0 | 1 | 0 | | C | | | | 0 | 6 | 9 | 0 | | | 0 | 3 | 4 | 3 |
| 0 | 2 | 0 | | B | | | | 0 | 9 | 2 | 7 | | | | | | / |

Assembled Instructions: C 690 343
B 927 /

Figure 13. Compare

Timing

Print Cycle

Whether printing on continuous forms or on card forms, the basic print cycle (Figure 14) is the same. The 100-ms print cycle permits 16 ms of processing. The 1401 system is interlocked for the 84-ms print time. Processing can take place during the remaining 16 ms. Forms movement for single spacing is overlapped during the last 20 ms of the cycle. If additional forms movement time is required, this time must be added to the basic 100-ms cycle to determine printing speed.

With the special feature, print storage, all but 2 ms are available for processing. The print storage area itself is interlocked for the 84 ms during printing.

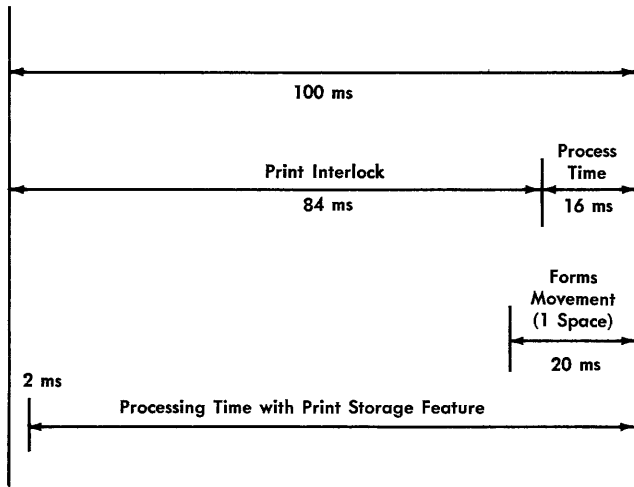

Figure 14. Print Timing Chart

Continuous Forms

When printing on continuous forms, the IBM 1404 Printer operates under timing conditions similar to those of the IBM 1403 Printer. For these timing details, refer to the *IBM 1401 Data Processing System Reference Manual*, Form A24-1403.

Card Forms

When printing one line on each card (the first available printing line), and spacing at 6 lines per inch the maximum output is 400 cards per minute for each card channel. Spacing at 8 lines per inch, the maximum rated speed for each channel is 359 cards per minute. For illustrative purposes, the charts and diagrams shown in this discussion reflect 6-lines-per-inch spacing requirements.

If printing occurs on other than the first line available for printing, the rated speed (card output) decreases. This is because, after the skip to 1, the distance between the card at the printing station (positioned at the first line to be printed), and the card at the aligning station is greater; thus, more time is needed to move a card into the first printing position. Card output also decreases as the number of lines printed on each card increases.

In Figure 15, for instance, the time required to skip to line 6 of each card is 81.5 ms. This makes a total of 165.5 ms for a complete feed and print cycle. In Figure 16, the time required to skip to line 6 is 79.2 ms. The skip time is less in this instance, because the actual skipping distance is less (by one space). Because printing occurs on lines 6 and 7, the F instruction causes skipping from line 7 of one card to line 6 of the card following.

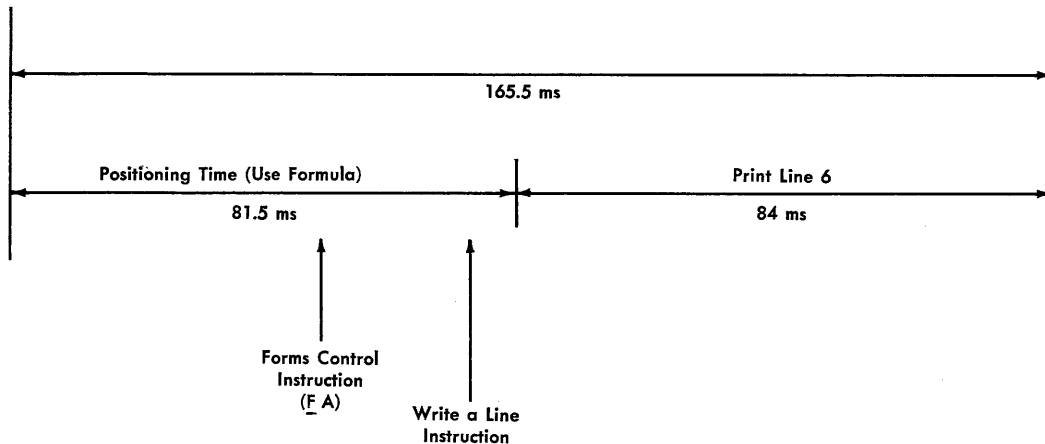

Figure 15. Print Line 6 of Each Card

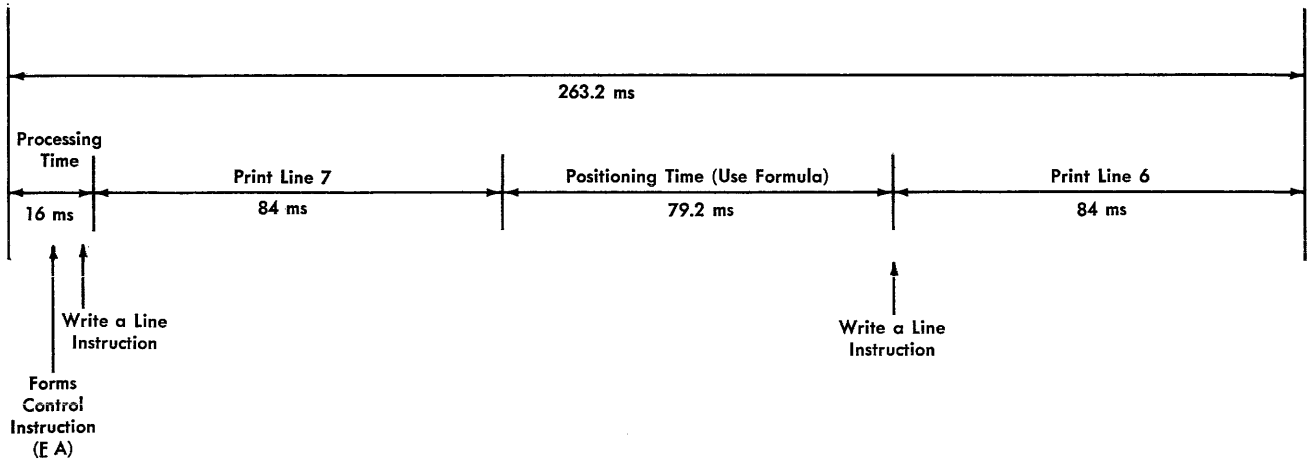

Figure 16. Print Lines 6 and 7 of Each Card

Calculating Positioning Time

Positioning time is the time it takes a card to move from the aligning station to a position in the print station that corresponds to the hole in the first channel of the paper tape. Because this time varies according to the first and last lines to be printed, it is necessary to know how this time is calculated.

To perform this calculation, use the formula
 $70 + 2.3(2F-L-1)$.

In this formula:

F is the line printed first.

L is the last line positioned for printing before eject.

After an F A instruction, L is the last line printed.

After an F 1 instruction, L is the *line following* the last line printed (because of the automatic line space after printing). If an F 1 instruction is used, add 20 ms for the automatic space.

IBM 1404 Card Reading

The card document feeding mechanism is controlled by a multi-tooth clutch that completes one revolution every 150 ms. If a signal to feed (F A or F 1) is received by the clutch, a card is fed as soon as the next tooth is at the proper position (clutch point). The clutch points are 12.5 ms apart.

The basic 1404 card feed cycle requires a total of 150 ms (Figure 17). The cycle is divided into three major sections:

1. Feed start time is 31.2 ms. This is the interval of time between the beginning of card movement, and the reading of the 9th or 12th row of the card (depending on which way the cards are fed — 9 or 12 edge first).
2. Card read time is 75 ms. This is when the card is actually read, and the data is moved into core storage. The processing unit is interlocked during card reading time.

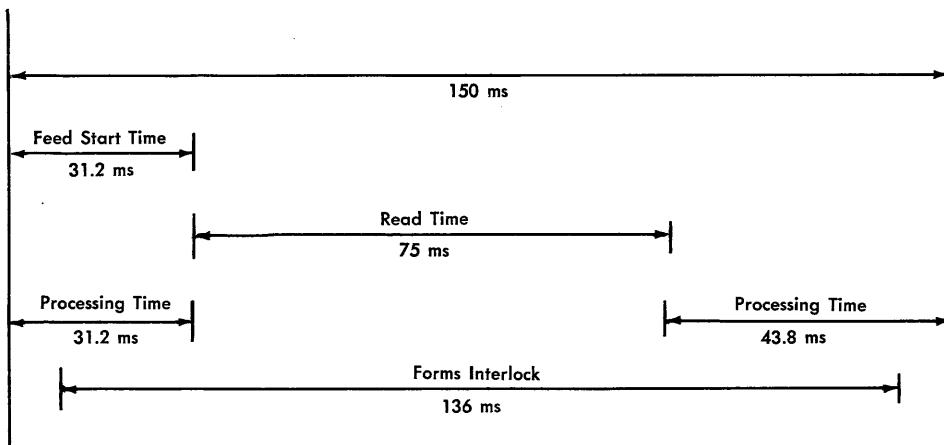

Figure 17. Read Timing Chart, IBM 1404

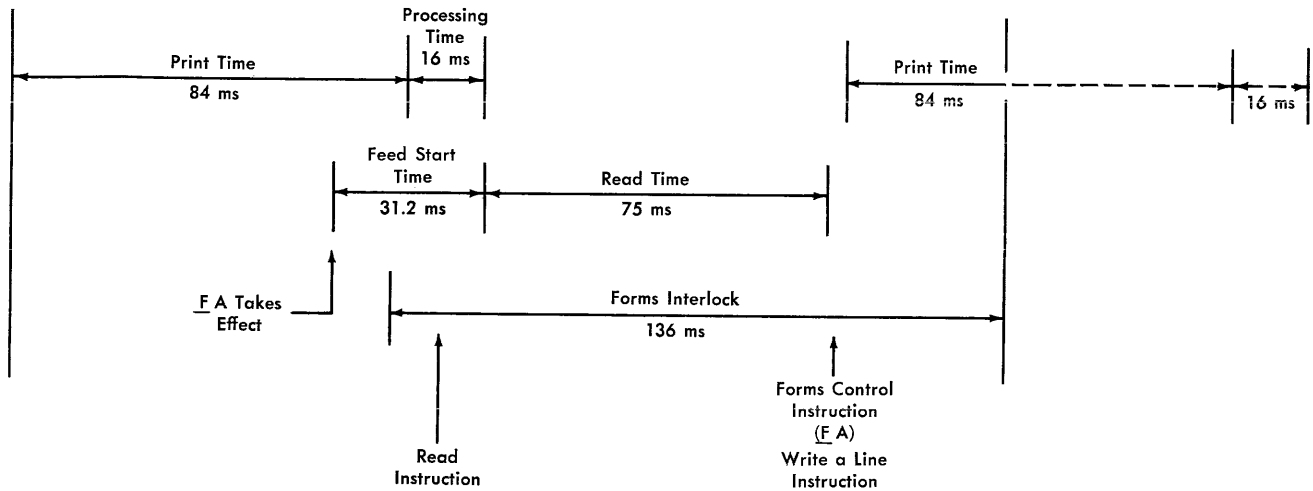

Figure 18. Print and Read Timing Chart, IBM 1404

3. Processing time is 43.8 ms. Because processing can also take place during the 31.2 ms of feed start time, actual total processing time during the complete cycle is 75 ms. To maintain maximum speed, the F instruction for the following cycle must be given at least 31.2 ms before the end of this total 75-ms processing time.

The read instruction (1 0) must follow an F 1 (CARD EJECT) instruction or the instructions F A (CARD EJECT AFTER PRINT) and 2 (PRINT). If the 1401 system does not have the print storage feature:

1. the read instruction must follow F 1 by not more than 31.2 ms (time for the feed to engage, and the

card to move to the read-compare brushes). If given after the 31.2-ms period, the 1404 will interlock the system in the I-cycle of the read operation.

2. the read instruction must follow F A and 2 by no less than 84 ms, and no more than 100 ms (Figure 18).

If the system is installed with the print storage feature:

1. the read instruction (1 0) must follow F 1 by no more than 31.2 ms (Figure 19). Note that this is true with or without print storage, because printing is not involved with the F 1 instruction.

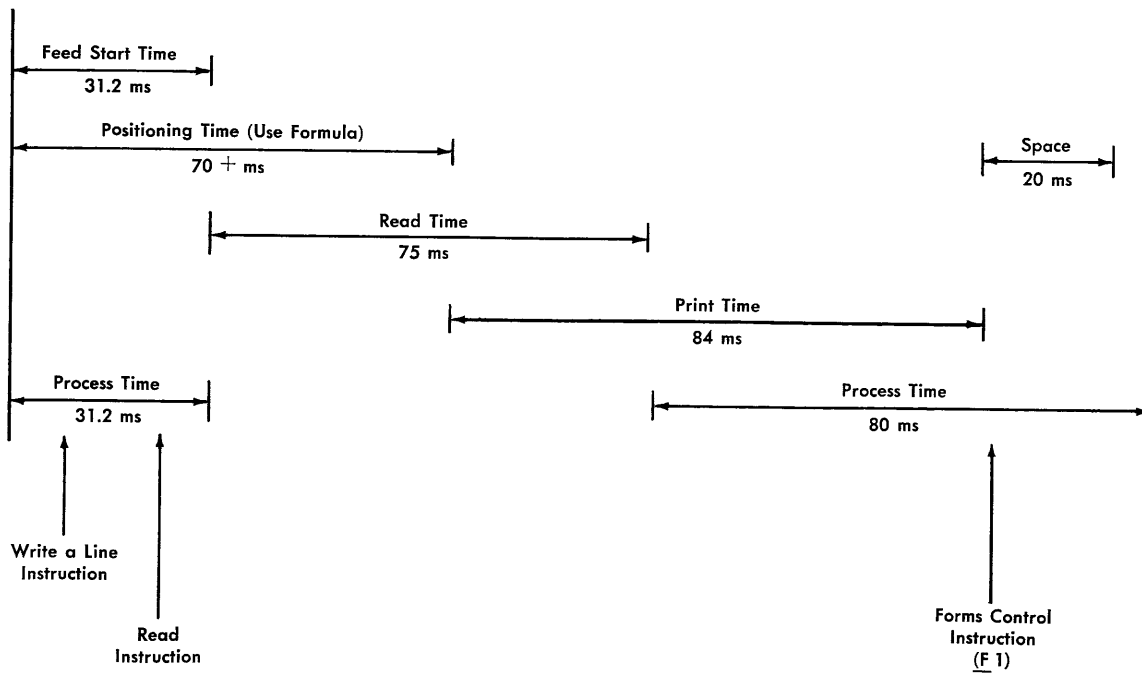

Figure 19. Print and Read Timing Chart, IBM 1404 (with Print Storage)

2. After F A and 2 instructions, the read instruction can be given any time other than the 2-ms period during which the print storage unit is loaded.

Print and Read Timing Charts

Figures 20 and 21 illustrate the time necessary to print (4 lines), and read each card as it passes through the card feeding mechanism. *Without* the special feature, print storage, the print instruction (2) cannot take effect

until the read cycle has been completed. *With* print storage, printing can begin as soon as the card is positioned in the printing station.

The use of the *skip after print* instruction (F A) saves time (16 ms) by ejecting the card immediately after 84 ms of the 9th-line print cycle. An F 1 instruction causes an automatic space after printing the 9th line.

By using the principles illustrated in these timing charts, as well as the formula for calculating positioning time, timings for other applications can be figured.

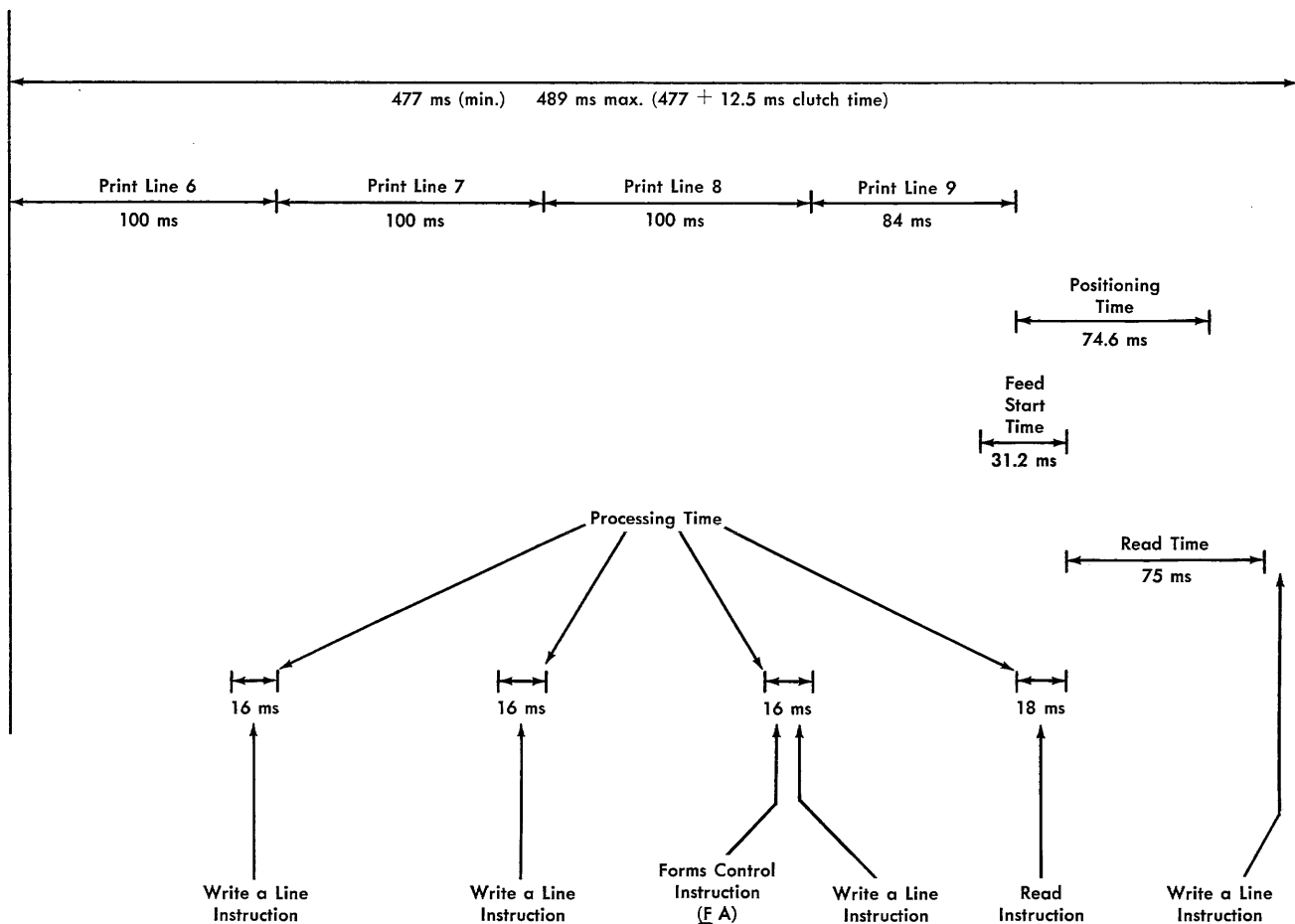

Figure 20. Print (4 Lines) and Read Timing Chart, IBM 1404

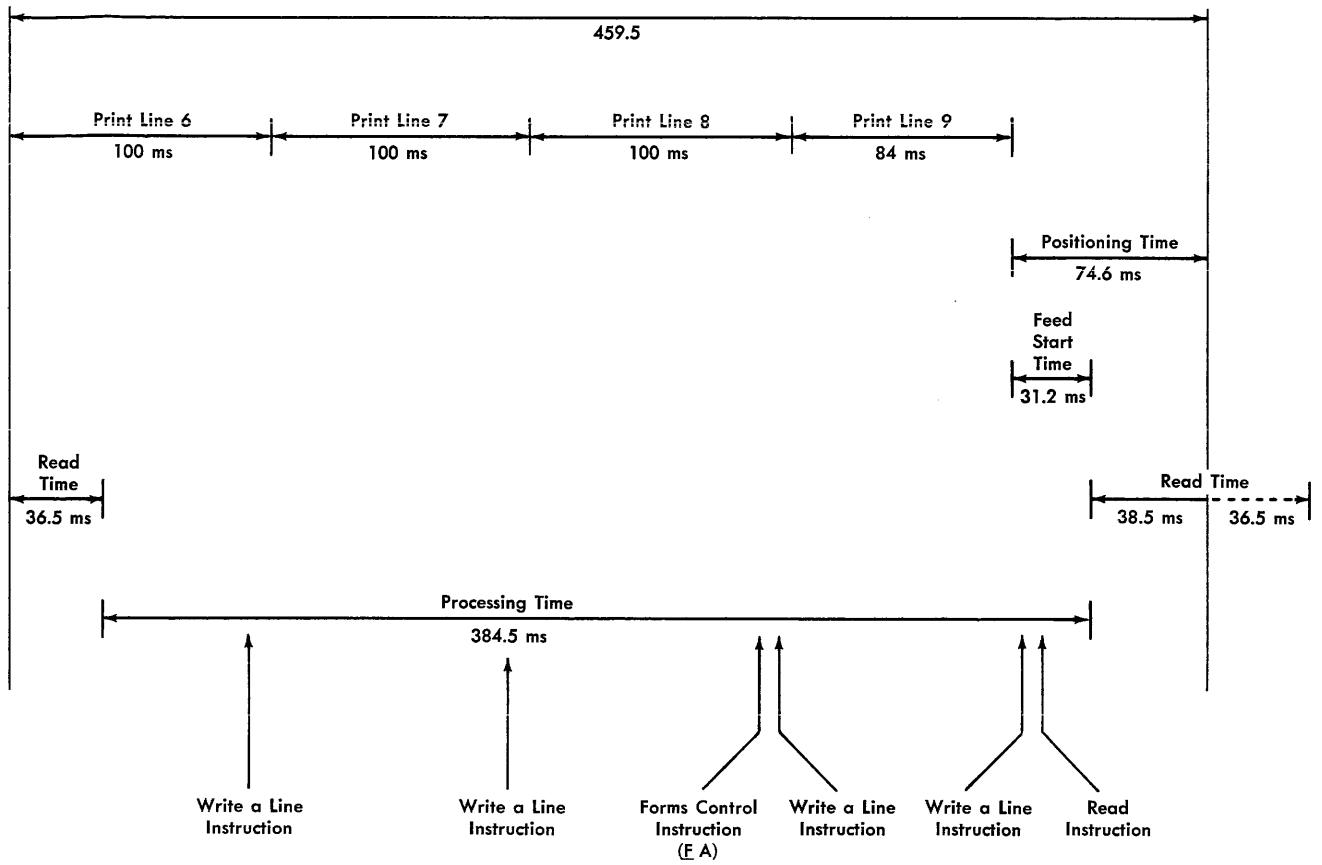

Figure 21. Print (4 Lines) and Read Timing Chart, IBM 1404 (with Print Storage)

IBM

International Business Machines Corporation
Data Processing Division
112 East Post Road, White Plains, New York